

## General Purpose NPN Transistor Arrays

November 1996

### Features

- Two Matched Transistors
  - $V_{BE}$  Match .....  $\pm 5\text{mV}$
  - $I_{IO}$  Match .....  $2\mu\text{A (Max)}$
- Low Noise Figure ..... 3.2dB (Typ) at 1kHz
- 5 General Purpose Monolithic Transistors
- Operation From DC to 120MHz
- Wide Operating Current Range
- Full Military Temperature Range

### Applications

- Three Isolated Transistors and One Differentially Connected Transistor Pair for Low Power Applications at Frequencies from DC Through the VHF Range
- Custom Designed Differential Amplifiers
- Temperature Compensated Amplifiers
- See Application Note, AN5296 "Application of the CA3018 Integrated-Circuit Transistor Array" for Suggested Applications

### Description

The CA3045 and CA3046 each consist of five general purpose silicon NPN transistors on a common monolithic substrate. Two of the transistors are internally connected to form a differentially connected pair.

The transistors of the CA3045 and CA3046 are well suited to a wide variety of applications in low power systems in the DC through VHF range. They may be used as discrete transistors in conventional circuits. However, in addition, they provide the very significant inherent integrated circuit advantages of close electrical and thermal matching.

### Ordering Information

PART NUMBER (BRAND)	TEMP. RANGE (°C)	PACKAGE	PKG. NO.
CA3045	-55 to 125	14 Ld SBDIP	D14.3
CA3045F	-55 to 125	14 Ld CERDIP	F14.3
CA3046	-55 to 125	14 Ld PDIP	E14.3
CA3046M (3046)	-55 to 125	14 Ld SOIC	M14.15
CA3046M96 (3046)	-55 to 125	14 Ld SOIC Tape and Reel	M14.15

### Pinout

CA3045, (CERDIP, SBDIP)  
CA3046 (PDIP, SOIC)  
TOP VIEW

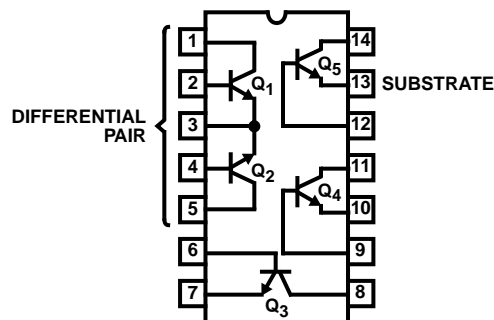

# CA3045, CA3046

## Absolute Maximum Ratings

Collector-to-Emitter Voltage ( $V_{CEO}$ )	15V
Collector-to-Base Voltage ( $V_{CBO}$ )	20V
Collector-to-Substrate Voltage ( $V_{CIO}$ , Note 1)	20V
Emitter-to-Base Voltage ( $V_{EBO}$ )	5V
Collector Current ( $I_C$ )	50mA

## Thermal Information

Thermal Resistance (Typical, Note 2)	$\theta_{JA}$ (°C/W)	$\theta_{JC}$ (°C/W)
PDIP Package	180	N/A
CERDIP Package	150	75
SBDIP Package	125	60
SOIC Package	220	N/A
Maximum Power Dissipation (Any One Transistor)	300mW	
Maximum Junction Temperature (Hermetic Packages)	175°C	
Maximum Junction Temperature (Plastic Package)	150°C	
Maximum Storage Temperature Range	-65°C to 150°C	
Maximum Lead Temperature (Soldering 10s)	300°C (SOIC - Lead Tips Only)	

## Operating Conditions

Temperature Range	-55°C to 125°C
-------------------	----------------

**CAUTION:** Stresses above those listed in "Absolute Maximum Ratings" may cause permanent damage to the device. This is a stress only rating and operation of the device at these or any other conditions above those indicated in the operational sections of this specification is not implied.

### NOTES:

- The collector of each transistor of the CA3045 and CA3046 is isolated from the substrate by an integral diode. The substrate (Terminal 13) must be connected to the most negative point in the external circuit to maintain isolation between transistors and to provide for normal transistor action.
- $\theta_{JA}$  is measured with the component mounted on an evaluation PC board in free air.

## Electrical Specifications $T_A = 25^\circ\text{C}$ , characteristics apply for each transistor in CA3045 and CA3046 as specified

PARAMETER	SYMBOL	TEST CONDITIONS	MIN	TYP	MAX	UNITS	
<b>DC CHARACTERISTICS</b>							
Collector-to-Base Breakdown Voltage	$V_{(BR)CBO}$	$I_C = 10\mu\text{A}, I_E = 0$	20	60	-	V	
Collector-to-Emitter Breakdown Voltage	$V_{(BR)CEO}$	$I_C = 1\text{mA}, I_B = 0$	15	24	-	V	
Collector-to-Substrate Breakdown Voltage	$V_{(BR)CIO}$	$I_C = 10\mu\text{A}, I_{CI} = 0$	20	60	-	V	
Emitter-to-Base Breakdown Voltage	$V_{(BR)EBO}$	$I_E = 10\mu\text{A}, I_C = 0$	5	7	-	V	
Collector Cutoff Current (Figure 1)	$I_{CBO}$	$V_{CB} = 10\text{V}, I_E = 0$	-	0.002	40	nA	
Collector Cutoff Current (Figure 2)	$I_{CEO}$	$V_{CE} = 10\text{V}, I_B = 0$	-	See Fig. 2	0.5	$\mu\text{A}$	
Forward Current Transfer Ratio (Static Beta) (Note 3) (Figure 3)	$h_{FE}$	$V_{CE} = 3\text{V}$	$I_C = 10\text{mA}$	-	100	-	-
			$I_C = 1\text{mA}$	40	100	-	-
			$I_C = 10\mu\text{A}$	-	54	-	-
Input Offset Current for Matched Pair $Q_1$ and $Q_2$ . $ I_{O1} - I_{O2} $ (Note 3) (Figure 4)		$V_{CE} = 3\text{V}, I_C = 1\text{mA}$	-	0.3	2	$\mu\text{A}$	
Base-to-Emitter Voltage (Note 3) (Figure 5)	$V_{BE}$	$V_{CE} = 3\text{V}$	$I_E = 1\text{mA}$	-	0.715	-	V
			$I_E = 10\text{mA}$	-	0.800	-	V
Magnitude of Input Offset Voltage for Differential Pair $ V_{BE1} - V_{BE2} $ (Note 3) (Figures 5, 7)		$V_{CE} = 3\text{V}, I_C = 1\text{mA}$	-	0.45	5	mV	
Magnitude of Input Offset Voltage for Isolated Transistors $ V_{BE3} - V_{BE4} ,  V_{BE4} - V_{BE5} ,  V_{BE5} - V_{BE3} $ (Note 3) (Figures 5, 7)		$V_{CE} = 3\text{V}, I_C = 1\text{mA}$	-	0.45	5	mV	
Temperature Coefficient of Base-to-Emitter Voltage (Figure 6)	$\frac{\Delta V_{BE}}{\Delta T}$	$V_{CE} = 3\text{V}, I_C = 1\text{mA}$	-	-1.9	-	mV/°C	
Collector-to-Emitter Saturation Voltage	$V_{CES}$	$I_B = 1\text{mA}, I_C = 10\text{mA}$	-	0.23	-	V	
Temperature Coefficient: Magnitude of Input Offset Voltage (Figure 7)	$\frac{ \Delta V_{IO} }{\Delta T}$	$V_{CE} = 3\text{V}, I_C = 1\text{mA}$	-	1.1	-	$\mu\text{V}/^\circ\text{C}$	

# CA3045, CA3046

**Electrical Specifications**  $T_A = 25^\circ\text{C}$ , characteristics apply for each transistor in CA3045 and CA3046 as specified (Continued)

PARAMETER	SYMBOL	TEST CONDITIONS	MIN	TYP	MAX	UNITS
<b>DYNAMIC CHARACTERISTICS</b>						
Low Frequency Noise Figure (Figure 9)	NF	$f = 1\text{kHz}$ , $V_{CE} = 3\text{V}$ , $I_C = 100\mu\text{A}$ , Source Resistance = $1\text{k}\Omega$	-	3.25	-	dB
Low Frequency, Small Signal Equivalent Circuit Characteristics						
Forward Current Transfer Ratio (Figure 11)	$h_{FE}$	$f = 1\text{kHz}$ , $V_{CE} = 3\text{V}$ , $I_C = 1\text{mA}$	-	110	-	-
Short Circuit Input Impedance (Figure 11)	$h_{iE}$	$f = 1\text{kHz}$ , $V_{CE} = 3\text{V}$ , $I_C = 1\text{mA}$	-	3.5	-	$\text{k}\Omega$
Open Circuit Output Impedance (Figure 11)	$h_{oE}$	$f = 1\text{kHz}$ , $V_{CE} = 3\text{V}$ , $I_C = 1\text{mA}$	-	15.6	-	$\mu\text{S}$
Open Circuit Reverse Voltage Transfer Ratio (Figure 11)	$h_{RE}$	$f = 1\text{kHz}$ , $V_{CE} = 3\text{V}$ , $I_C = 1\text{mA}$	-	$1.8 \times 10^{-4}$	-	-
Admittance Characteristics						
Forward Transfer Admittance (Figure 12)	$Y_{FE}$	$f = 1\text{kHz}$ , $V_{CE} = 3\text{V}$ , $I_C = 1\text{mA}$	-	$31 - j1.5$	-	-
Input Admittance (Figure 13)	$Y_{iE}$	$f = 1\text{kHz}$ , $V_{CE} = 3\text{V}$ , $I_C = 1\text{mA}$	-	$0.3 + j0.04$	-	-
Output Admittance (Figure 14)	$Y_{oE}$	$f = 1\text{kHz}$ , $V_{CE} = 3\text{V}$ , $I_C = 1\text{mA}$	-	$0.001 + j0.03$	-	-
Reverse Transfer Admittance (Figure 15)	$Y_{RE}$	$f = 1\text{kHz}$ , $V_{CE} = 3\text{V}$ , $I_C = 1\text{mA}$	-	See Fig. 14	-	-
Gain Bandwidth Product (Figure 16)	$f_T$	$V_{CE} = 3\text{V}$ , $I_C = 3\text{mA}$	300	550	-	MHz
Emitter-to-Base Capacitance	$C_{EB}$	$V_{EB} = 3\text{V}$ , $I_E = 0$	-	0.6	-	pF
Collector-to-Base Capacitance	$C_{CB}$	$V_{CB} = 3\text{V}$ , $I_C = 0$	-	0.58	-	pF
Collector-to-Substrate Capacitance	$C_{CI}$	$V_{CS} = 3\text{V}$ , $I_C = 0$	-	2.8	-	pF

NOTE:

- Actual forcing current is via the emitter for this test.

## Typical Performance Curves

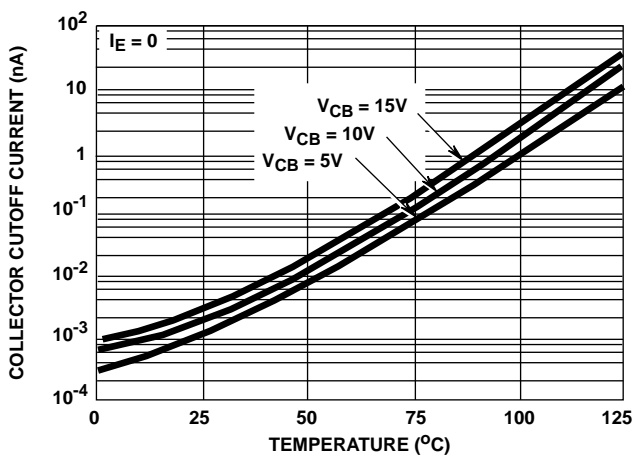

FIGURE 1. TYPICAL COLLECTOR-TO-BASE CUTOFF CURRENT vs TEMPERATURE FOR EACH TRANSISTOR

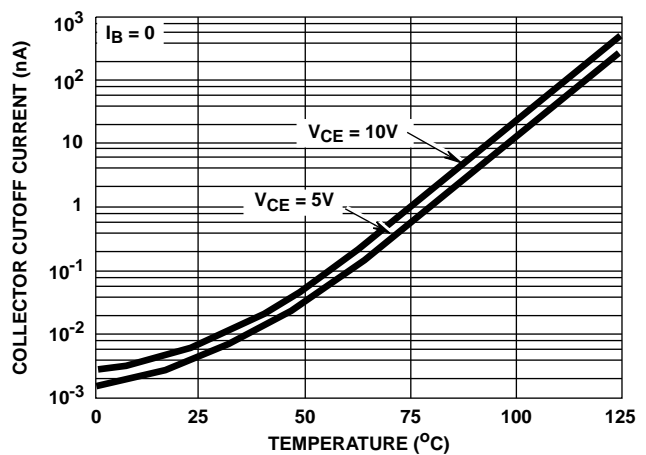

FIGURE 2. TYPICAL COLLECTOR-TO-EMITTER CUTOFF CURRENT vs TEMPERATURE FOR EACH TRANSISTOR

Typical Performance Curves (Continued)

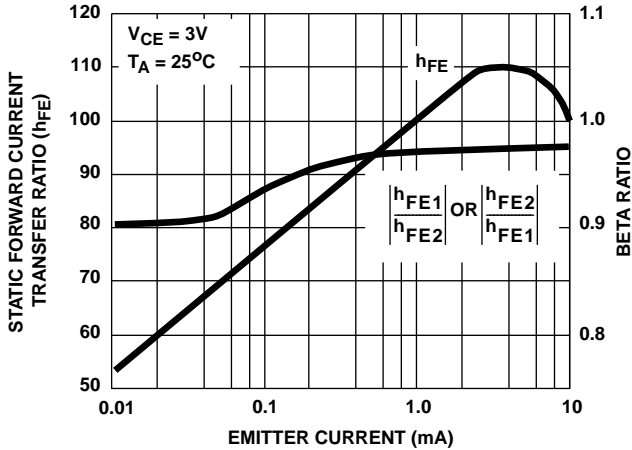

FIGURE 3. TYPICAL STATIC FORWARD CURRENT TRANSFER RATIO AND BETA RATIO FOR Q<sub>1</sub> AND Q<sub>2</sub> vs EMITTER CURRENT

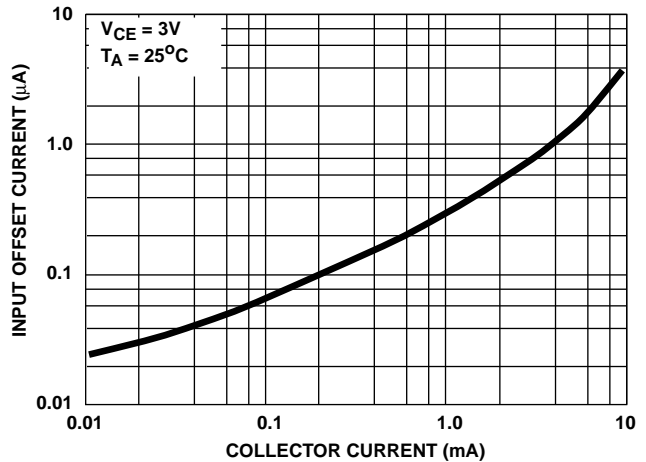

FIGURE 4. TYPICAL INPUT OFFSET CURRENT FOR MATCHED TRANSISTOR PAIR Q<sub>1</sub>Q<sub>2</sub> vs COLLECTOR CURRENT

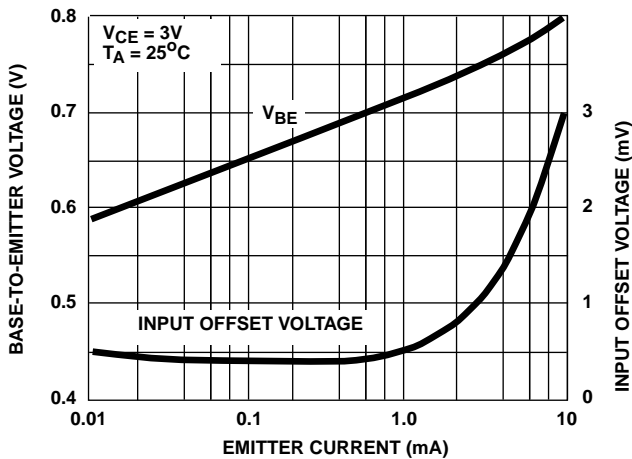

FIGURE 5. TYPICAL STATIC BASE-TO-EMITTER VOLTAGE CHARACTERISTICS AND INPUT OFFSET VOLTAGE FOR DIFFERENTIAL PAIR AND PAIRED ISOLATED TRANSISTORS vs EMITTER CURRENT

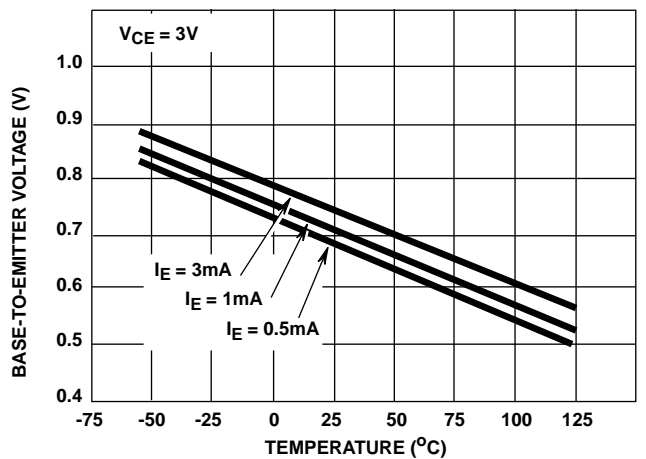

FIGURE 6. TYPICAL BASE-TO-EMITTER VOLTAGE CHARACTERISTIC vs TEMPERATURE FOR EACH TRANSISTOR

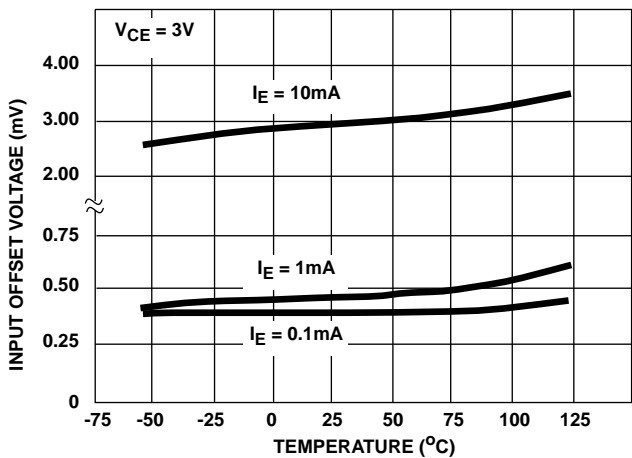

FIGURE 7. TYPICAL INPUT OFFSET VOLTAGE CHARACTERISTICS FOR DIFFERENTIAL PAIR AND PAIRED ISOLATED TRANSISTORS vs TEMPERATURE

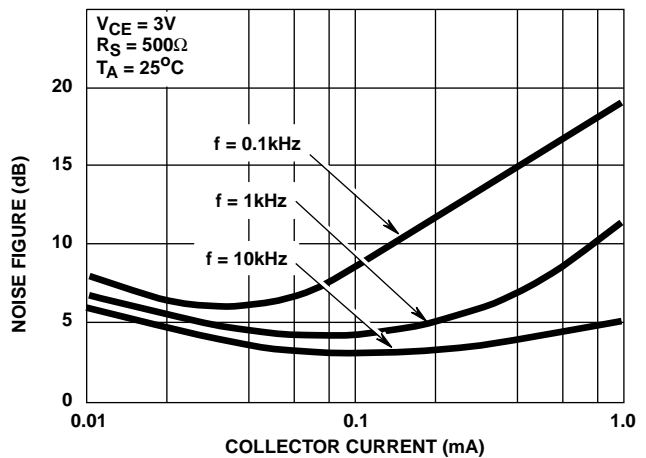

FIGURE 8. TYPICAL NOISE FIGURE vs COLLECTOR CURRENT

Typical Performance Curves (Continued)

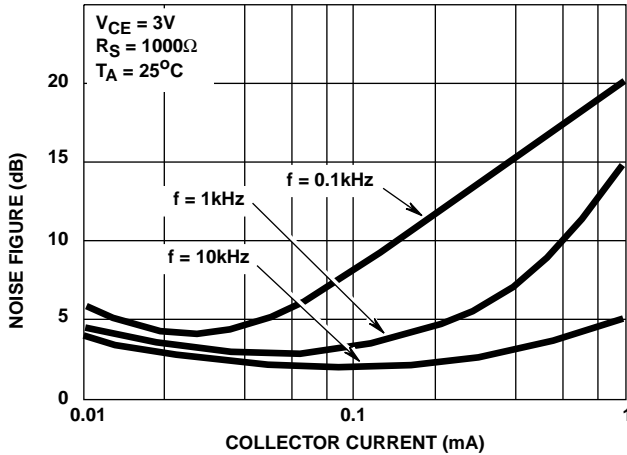

FIGURE 9. TYPICAL NOISE FIGURE vs COLLECTOR CURRENT

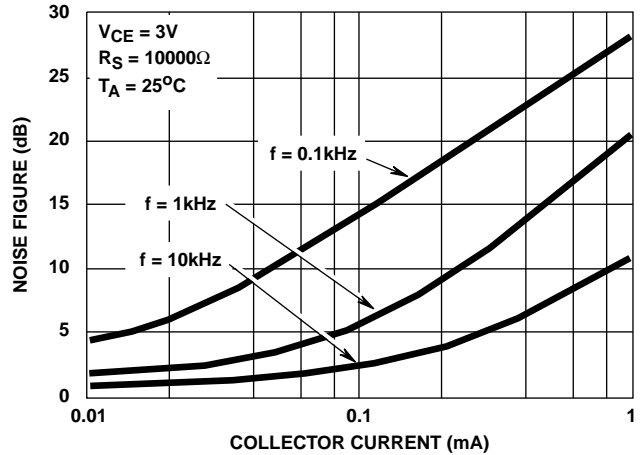

FIGURE 10. TYPICAL NOISE FIGURE vs COLLECTOR CURRENT

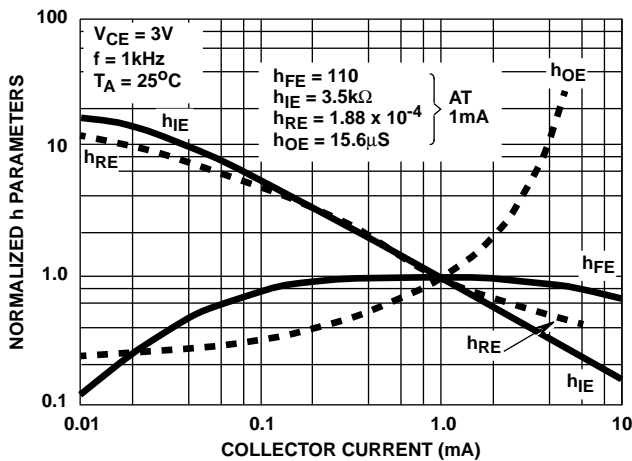

FIGURE 11. TYPICAL NORMALIZED FORWARD CURRENT TRANSFER RATIO, SHORT CIRCUIT INPUT IMPEDANCE, OPEN CIRCUIT OUTPUT IMPEDANCE, AND OPEN CIRCUIT REVERSE VOLTAGE TRANSFER RATIO vs COLLECTOR CURRENT

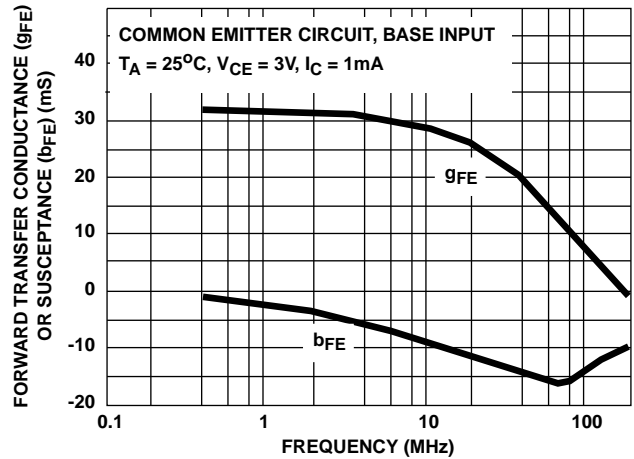

FIGURE 12. TYPICAL FORWARD TRANSFER ADMITTANCE vs FREQUENCY

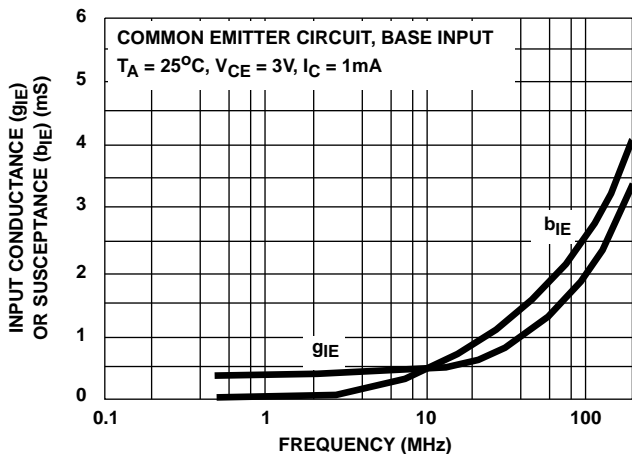

FIGURE 13. TYPICAL INPUT ADMITTANCE vs FREQUENCY

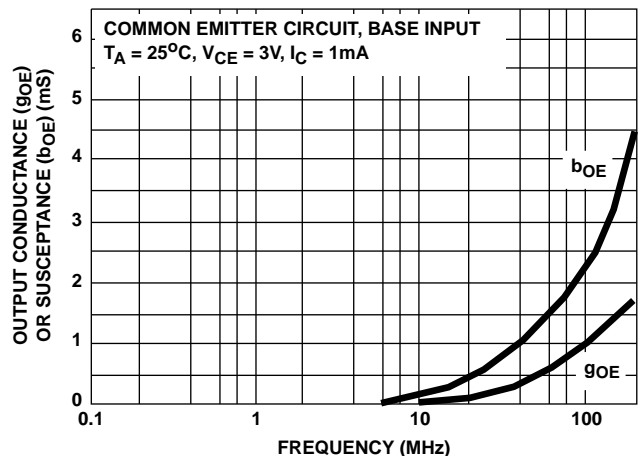

FIGURE 14. TYPICAL OUTPUT ADMITTANCE vs FREQUENCY

Typical Performance Curves (Continued)

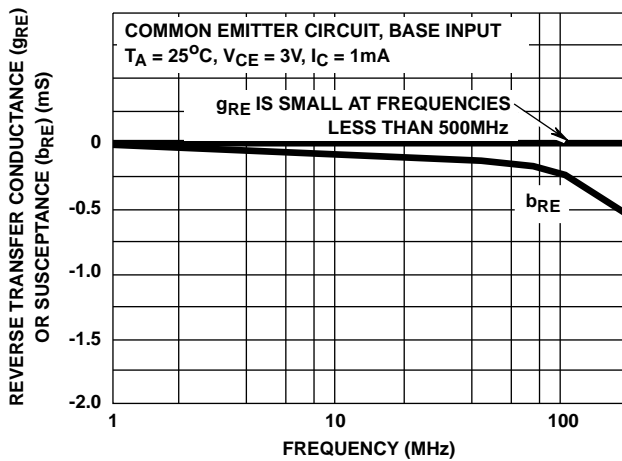

FIGURE 15. TYPICAL REVERSE TRANSFER ADMITTANCE vs FREQUENCY

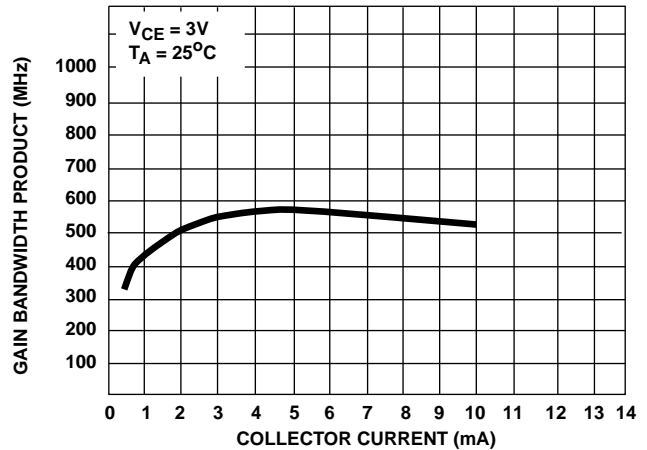

FIGURE 16. TYPICAL GAIN BANDWIDTH PRODUCT vs COLLECTOR CURRENT

All Harris Semiconductor products are manufactured, assembled and tested under **ISO9000** quality systems certification.

*Harris Semiconductor products are sold by description only. Harris Semiconductor reserves the right to make changes in circuit design and/or specifications at any time without notice. Accordingly, the reader is cautioned to verify that data sheets are current before placing orders. Information furnished by Harris is believed to be accurate and reliable. However, no responsibility is assumed by Harris or its subsidiaries for its use; nor for any infringements of patents or other rights of third parties which may result from its use. No license is granted by implication or otherwise under any patent or patent rights of Harris or its subsidiaries.*

**Sales Office Headquarters**

For general information regarding Harris Semiconductor and its products, call **1-800-4-HARRIS**

**NORTH AMERICA**  
 Harris Semiconductor  
 P. O. Box 883, Mail Stop 53-210  
 Melbourne, FL 32902  
 TEL: 1-800-442-7747  
 (407) 729-4984  
 FAX: (407) 729-5321

**EUROPE**  
 Harris Semiconductor  
 Mercure Center  
 100, Rue de la Fusee  
 1130 Brussels, Belgium  
 TEL: (32) 2.724.2111  
 FAX: (32) 2.724.22.05

**ASIA**  
 Harris Semiconductor PTE Ltd.  
 No. 1 Tannery Road  
 Cencon 1, #09-01  
 Singapore 1334  
 TEL: (65) 748-4200  
 FAX: (65) 748-0400

